

Year 3 Optional SAT mark scheme paper B

1. 39 1 [1]

2. Numbers written in order as shown: 1

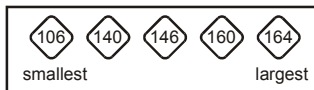

Do not accept reverse order.

[1]

3. Kylie 1

Accept any reasonable spelling, provided the intention is clear.

4. Two shapes ticked as shown: 1

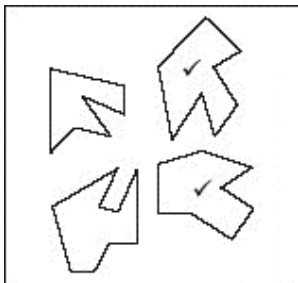

Both shapes must be correct for the award of the mark.

Accept any other clear way of indicating the correct two shapes, such as crosses or circling.

[1]

5. Completes the sequence as shown:

1

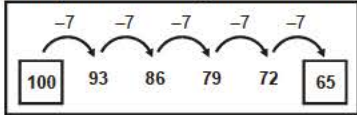

Both numbers must be correct for the award of the mark.

[1]

6. Number circled as shown:

1



Accept any other clear way of indicating the correct estimate, such as ticking the number.

[1]

7. 6½cm **OR** 6.5cm **OR** equivalent.





1

*Accept equivalent measurements, eg 65mm
Accept an answer in the range 6.3cm–6.7cm*

[1]

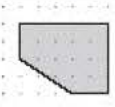
8. Table completed as shown:

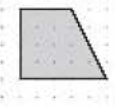
1

shape	number of right angles
	3.....
	2.....

Both numbers must be correct for the award of the mark.

[1]

9. 80

1

[1]

10. Two letters ticked as shown:

1



Both letters must be correct for the award of the mark.

Do not award the mark if either S or N are ticked.

Accept any other clear way of indicating the correct letters, such as 'Yes' or circling.

[1]

11. Award **TWO** marks for all six different two-digit numbers given in any order. Up to 2
U2

25	27	52	57	72	75
----	----	----	----	----	----

Award both marks even if any numbers are duplicated in the list, provided all six different numbers are given.





Do not accept 22 or 55 or 77 unless given in addition to the correct six numbers.

If the answer is incorrect, award **ONE** mark for five different correct numbers.

[2]

12. (a) Table completed as shown:

1
U1

favourite big cat	number of children
cheetah 	7
lion 	22
tiger 	13
leopard 	8
total	60

- (b) Statements indicated and circled as shown:

1

Line marked for the lion that the leopard



The lion was more popular than the tiger.



$\frac{1}{60}$ of the children voted for the tiger.



All three statements must be correct for the award of the mark. Accept a tick for any clear way of indicating the correct response, such as '✓' and 'N'.

Do not accept blanks.

[2]

13. Award **TWO** marks for the correct answer of £4.40

Up to 2

Accept £4.40p OR £4 40

If the answer is incorrect, award **ONE** mark for evidence of appropriate working, eg

$$10\text{p} \times 24 = \text{£}2.40$$

$$20\text{p} \times 10 = \text{£}2.00$$

$$\text{£}2.40 + \text{£}2.00 = \text{wrong answer}$$

*An answer must be given for the award of **ONE** mark.*

OR

award **ONE** mark for £440 **OR** £440p **OR** £4.4 as evidence of appropriate working which involves a complete and correct method.

[2]

Examples of responses

Peter has shown no working and has made an error with the notation of the units since he has omitted the 0 from £4.40. However, his answer of 4:4p can be accepted as evidence that he used a complete and correct method. He can be awarded the mark. Lucy has attempted to work out the value of the 10p coins using a correct method although she has incorrectly calculated this as 140p rather than 240p. She has also shown evidence that she intended to add ten 20p coins to this value. However, her method is not complete since she has not recorded an answer. She cannot be awarded the mark.

Peter

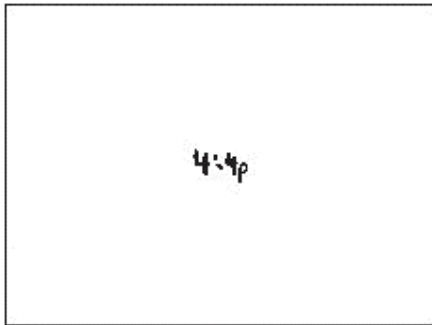

1 mark

Lucy

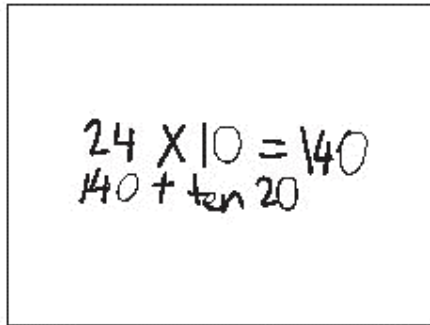

0 marks

Freddie has clearly shown an appropriate method for calculating the value of the 10p coins, the 20p coins and their total value. Although he made an error in calculating the value of the 20p coins, his understanding of the problem is evident and his method is complete and correct. He can be awarded the mark. Stella's method, unlike Freddie's, is not correct since she has chosen an inappropriate operation, ie addition rather than multiplication, to calculate the value of each set of coins. Stella cannot be awarded the mark.

Freddie

Stella

Handwritten work for Freddie:

$$\begin{array}{r} 10 \quad 10 \\ \times 4 \quad \times 20 \\ \hline 40p + 200p \\ \hline \pounds 2.40 \\ + \pounds 1.60 \\ \hline \pounds 4.00 \end{array}$$

4.00

Handwritten work for Stella:

$$\begin{array}{r} 24 + 10p = 34 \\ 10 + 20p = 30 \\ \hline 64 \end{array}$$

64

1 mark

0 marks

Surjit has drawn number lines to represent the 10p coins and the 20p coins. To find the total amount, she has subdivided the number lines into blocks representing £1 but made an error in her final calculation. Her method shows each step taken and her method is complete and correct. Surjit can be awarded the mark. Julian too has used a counting on method. He has shown the correct number of 20p coins, then has shown 20 tally marks, which we can assume represent 10p coins. We can also assume from his answer that he has totalled the amounts. Julian's method is correct, but it is not complete since his tally has not represented the correct number of 10p coins. Julian cannot be awarded the mark.

Surjit

Julian

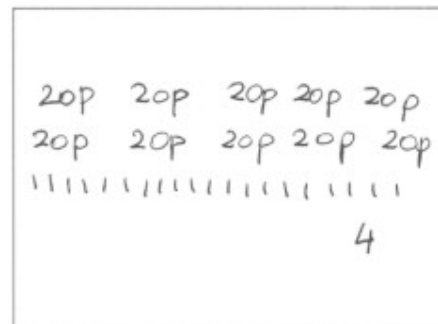
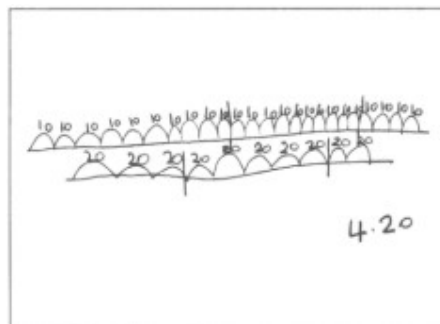

1 mark

0 marks

14. Any two of the eight triangles shaded, eg

1

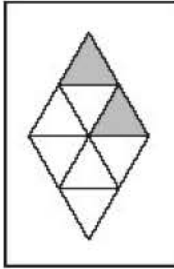

Accept any other unambiguous indication of the correct fraction, such as four half-triangles shaded.

[1]

15. 310

1

[1]

16. Circles two fractions as shown:

1

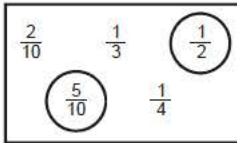

Both fractions must be correct for the award of the mark.
Accept any other clear way of indicating the correct fractions, such as ticking or underlining.

[1]

17. The two numbers matched correctly as shown:

1

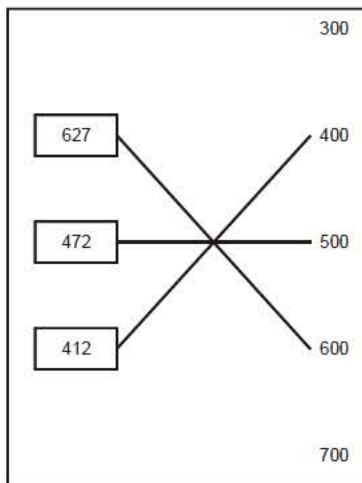

Both lines must be drawn correctly for the award of the mark.
Lines need not touch the boxes or numbers exactly, provided the intention is clear.
Do not accept two or more lines drawn from the same left-hand box.



[1]

18. Boxes completed as shown: 1

$$\boxed{9} \boxed{7} - \boxed{5} \boxed{4} = \boxed{43}$$

Both digits must be correct for the award of the mark.

19. Table completed as shown: 1

	number of faces	number of edges
 cuboid	6	12
 square-based pyramid	5	8

[1]

20. 823 1

[1]

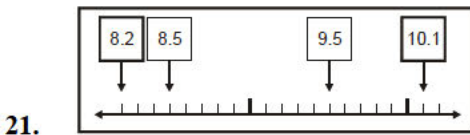

- (a) Writes 8.2 in the left-hand box. 1
 (b) Writes 10.1 in the righthand box. 1

[2]

22. 4 hours 30 minutes

Accept $4\frac{1}{2}$ hours if the minutes space is left blank OR 270 minutes if the hours space is left blank.

23. 92 1

[1]

24. Award **TWO** marks for the correct answer of 16

Up to 2
U1

If the answer is incorrect, award **ONE** mark for evidence of appropriate working which involves a complete and correct method, eg

$$12 \times 5 = 60$$

$$11 \times 4 = 44$$

$$60 + 44 = 104$$

$$120 - 104 = \text{wrong answer}$$

*An answer must be given for the award of **ONE** mark.*

[2]

Examples of responses

We can assume from Kate's first sentence that she correctly calculated 12 multiplied by 5 to equal 60 then added it to 44. So her explanation makes clear how she worked out that 104 pencils were used. In her attempt to subtract 104 from 120, she made an error but she describes a complete and correct method. Kate can be awarded the mark. In contrast, Bill attempted to explain how he worked out the total number of pencils used. However, as he has not recorded this total, we cannot assume that his answer of 20 was the difference between 120 and the total he calculated. His written description does not describe a complete method. Bill cannot be awarded the mark.

Kate

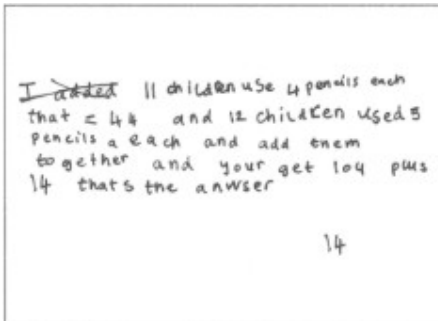

1 mark

Bill

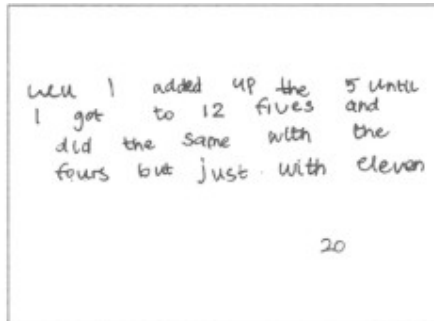

0 marks

Ashley has made one calculation error when working out 11 groups of 4. Although he has not recorded the method that he used to obtain his answer of 18, we can assume that his method was correct since $120 - 102 = 18$. There is sufficient evidence for us to assume that Ashley's method was complete and correct. Ashley can be awarded the mark. Paula also has calculated incorrectly 11 groups of 4 but, unlike Ashley, her follow-up working does not provide an appropriate method for calculating the number of pencils left. Her method is not complete or correct. Paula cannot be awarded the mark.

Ashley

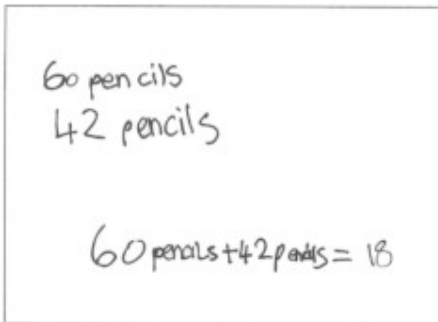

1 mark

Paula

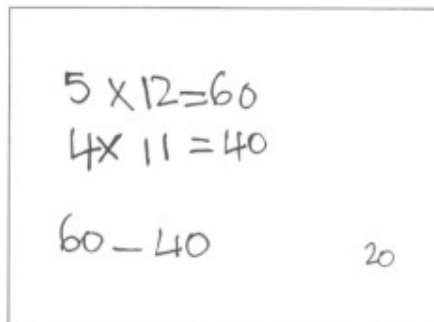

0 marks

Sumila has used a counting back method that shows that she recognised the need to subtract twelve groups of 5 and eleven groups of 4 from 120. She made one error in calculating 12 multiplied by 5. However, the method she used was complete and correct. Sumila can be awarded the mark. Michael also has used a counting back method but since he subtracted only one lot of 5 then one lot of 4 from 120 to obtain his answer, his working shows that he failed to identify a complete or correct method. Michael cannot be awarded the mark.

Sumila

$$120 - 50 = 70$$

$$70 - 44 = 26$$

26

1 mark

Michael

$$120 - 5 = 115$$

$$115 - 4 = 112$$

112

0 marks

25. Diagram completed as shown:

1

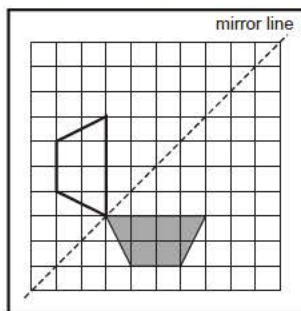

Accept slight inaccuracies in drawing, provided the intention is clear.

Vertices must be within 2mm of the correct grid points.

The reflection need not be shaded.

[1]

26. Number crossed as shown:

1

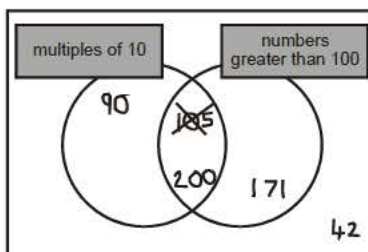

Accept any other clear way of indicating the appropriate number, such as a circle or a tick.

[1]

27. 48 1 [1]

28. 84p OR £0.84 1
Accept £0 84 OR £0.84p OR 0.84 OR 84 OR £.84 OR £.84p OR .84 OR 0 84
Do not accept 0.84p OR £084p OR £84 OR £84p [1]

29. Box ticked as shown: 1

4 millilitres	<input type="checkbox"/>
20 millilitres	<input type="checkbox"/>
120 millilitres	<input type="checkbox"/>
220 millilitres	<input checked="" type="checkbox"/>
420 millilitres	<input type="checkbox"/>

Accept any other clear way of indicating the approximate amount, such as a cross. [1]