

Key stage 3 mathematics 2006

Mental mathematics Test A

First name \_\_\_\_\_

Last name \_\_\_\_\_

School \_\_\_\_\_

Total marks

Practice question

		37	
--	--	----	--

Time: 5 seconds

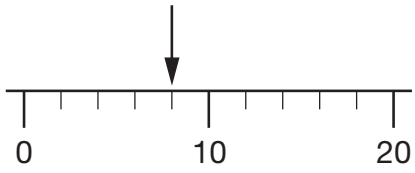
1			
---	-------------------------------------------------------------------------------------	--	--

2		300	
---	--	-----	--

3		9	
---	--	---	--

4	mm		
---	----	--	--

5		-2	
---	--	----	--



6			
---	--	--	--

Time: 5 seconds continued

7		3.68	
---	--	------	--

8		$10y^2 - 3y^2$	
---	--	----------------	--

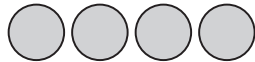
Time: 10 seconds

9	Right		
	Wrong		
pupils			

10	cm		
----	----	--	--

11	13					
	$\frac{1}{8}$	$\frac{1}{4}$	$\frac{1}{3}$	$\frac{1}{2}$	$\frac{3}{4}$	

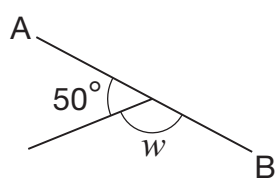
12			
----	---------------------------------------------------------------------------------------	--	--

13		$2x - 8$	
----	--	----------	--

14	10cm : 2km		15cm	
	km			

15			
----	--	--	--

16	£	5%	£300
----	---	----	------

**Time: 10 seconds continued**

17 2cm by 8cm by 4cm  
 $\text{cm}^3$

18 m £4.50 £27

19 cm 8cm

20 £ 1 : 3 £150

21  $y(y - 3)$

**Time: 15 seconds**

22  $27 \times 32 = 864$   
 $27 \times 16 =$

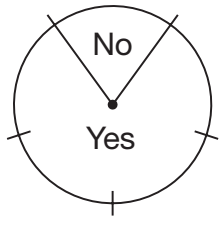
23  

24  50

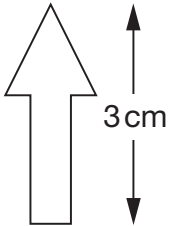
25  cm 

**Time: 15 seconds continued**

26

Number of milk bottles	Frequency
0	6
1	3
2	8
3	1
4	2

27  $\sqrt{40000}$

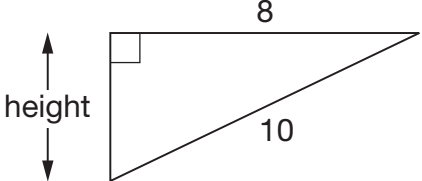
28 

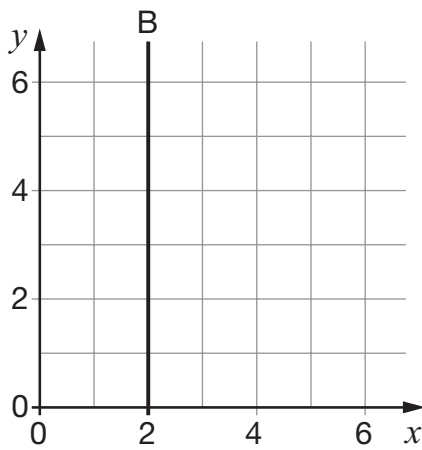
29 

30  $9 \times 9$